



GBU8005 thru GBU810

8.0 A Single-Phase Silicon Bridge Rectifier Rectifier Reverse Voltage 50 to 1000V

Features

- Ideal for printed circuit board mounting
- This series is UL listed under the Recognized Component Index, file number E484648
- The plastic material used carries Underwriters Laboratory flammability recognition 94V-0
- Built-in printed circuit board stand-offs
- High case dielectric strength
- High temperature soldering guaranteed 260°C / 5 seconds at 5 lbs (2.3kg) tension

Mechanical Data

Case: Reliable low cost construction utilizing molded plastic technique

Terminals: Plated leads solderable per MIL-STD-202, Method 208

Mounting Position: Any

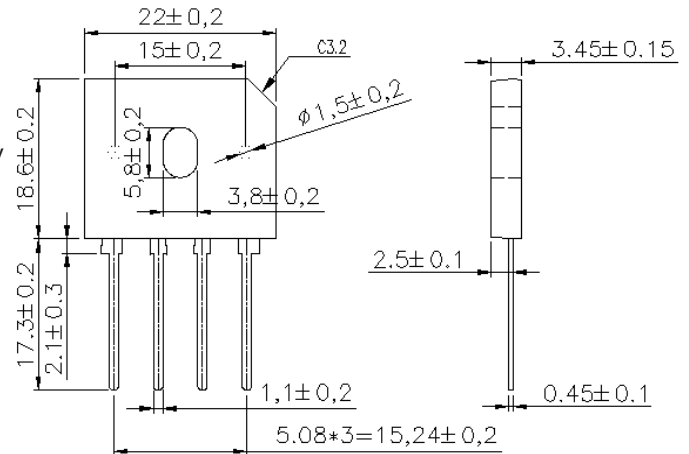

Dimensions in inches and (millimeters)

Maximum Ratings & Thermal Characteristics

Rating at 25°C ambient temperature unless otherwise specified, Resistive or Inductive load, 60 Hz.
For Capacitive load derate current by 20%.

Parameter	Symbol	GBU 8005	GBU 801	GBU 802	GBU 804	GBU 806	GBU 808	GBU 810	unit
Maximum repetitive peak reverse voltage	V_{RRM}	50	100	200	400	600	800	1000	V
Maximum RMS bridge input voltage	V_{RMS}	35	70	140	280	420	560	700	V
Maximum DC blocking voltage	V_{DC}	50	100	200	400	600	800	1000	V
Maximum average forward rectified output current at $T_C=100^\circ\text{C}$ (with heatsink)	$I_{F(AV)}$	8.0							A
Peak forward surge current single sine-wave superimposed on rated load (JEDEC Method)	I_{FSM}	175							A
Rating for fusing ($t < 8.3\text{ms}$)	I^2t	127							A^2sec
Operating junction and storage temperature range	T_J, T_{STG}	-55 to + 150							$^\circ\text{C}$

Electrical Characteristics

Rating at 25°C ambient temperature unless otherwise specified. Resistive or Inductive load, 60Hz.
For Capacitive load derate by 20 %.

Parameter	Symbol	GBU 8005	GBU 801	GBU 802	GBU 804	GBU 806	GBU 808	GBU 810	Unit
Maximum instantaneous forward voltage drop per leg at 4.0A	V_F	1.1							V
Maximum DC reverse current at rated $T_A=25^\circ\text{C}$ DC blocking voltage per element $T_A=125^\circ\text{C}$	I_R	10 500							μA

Notes: (1) Thermal resistance from Junction to Ambient on P.C. board mounting.

Rating and Characteristic Curves ($T_A=25^{\circ}\text{C}$ Unless otherwise noted)

GBU8005 thru GBU810

Fig. 1 Derating Curve for Output Rectified Current

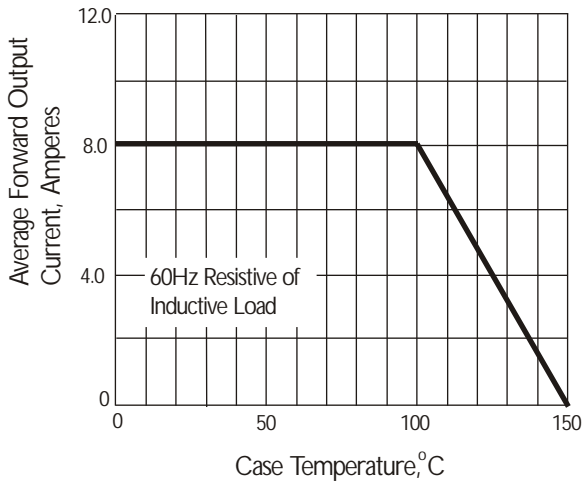

Fig. 2 Maximum Non-repetitive Peak Forward Surge Current

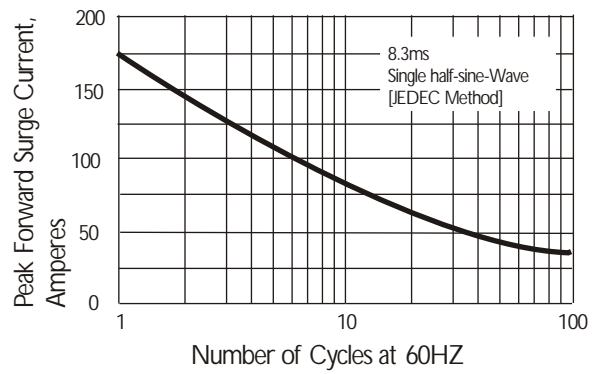

Fig. 3 Typical Instantaneous Forward Characteristics



Fig. 4 Typical Reverse Characteristics

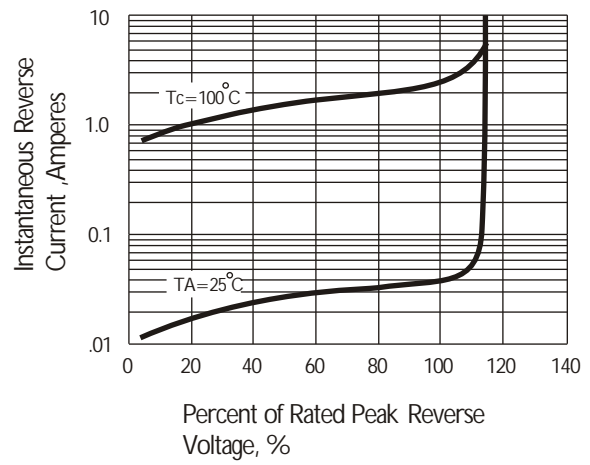

Fig. 5 Typical Junction Capacitance

